

REINFORCED CONCRETE PILE
 OF THE
 STATE HIGHWAY
 SOUTHERN TRAIL
 COUNTY OF SANTA BARBARA
 TATION 102+25 SECTION
 WITH OTHER COUNTY SURVEY
 MARYERRE PARKER + EDW. L. JOHNSON
 LOS ANGELES, CALIF.
 ASSOCIATED ENGINEERS
 JUNE 2, 1916

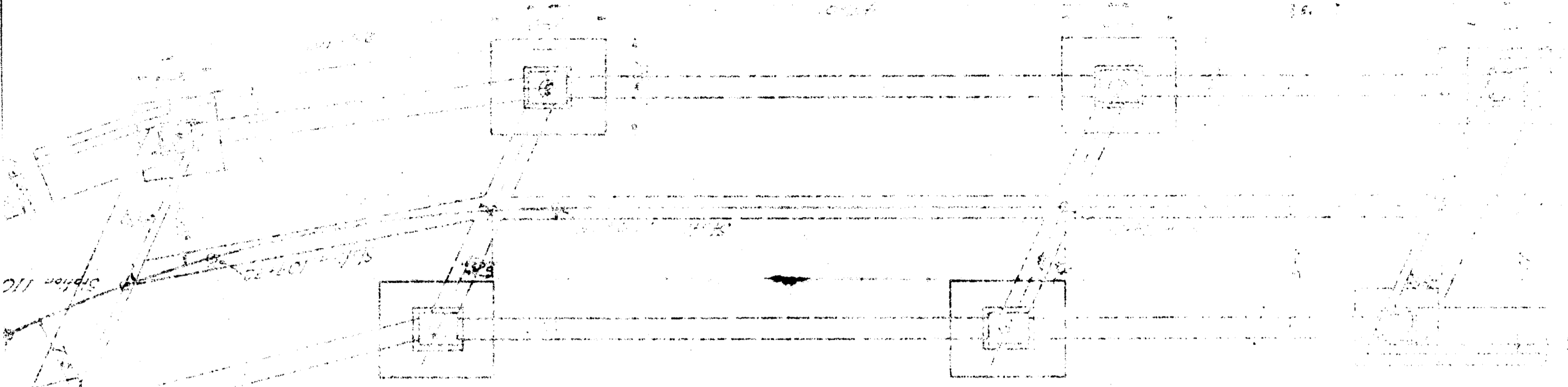

DETAIL OF EXPANSION JOINT
 SCALE 1/2" = 1'-0"

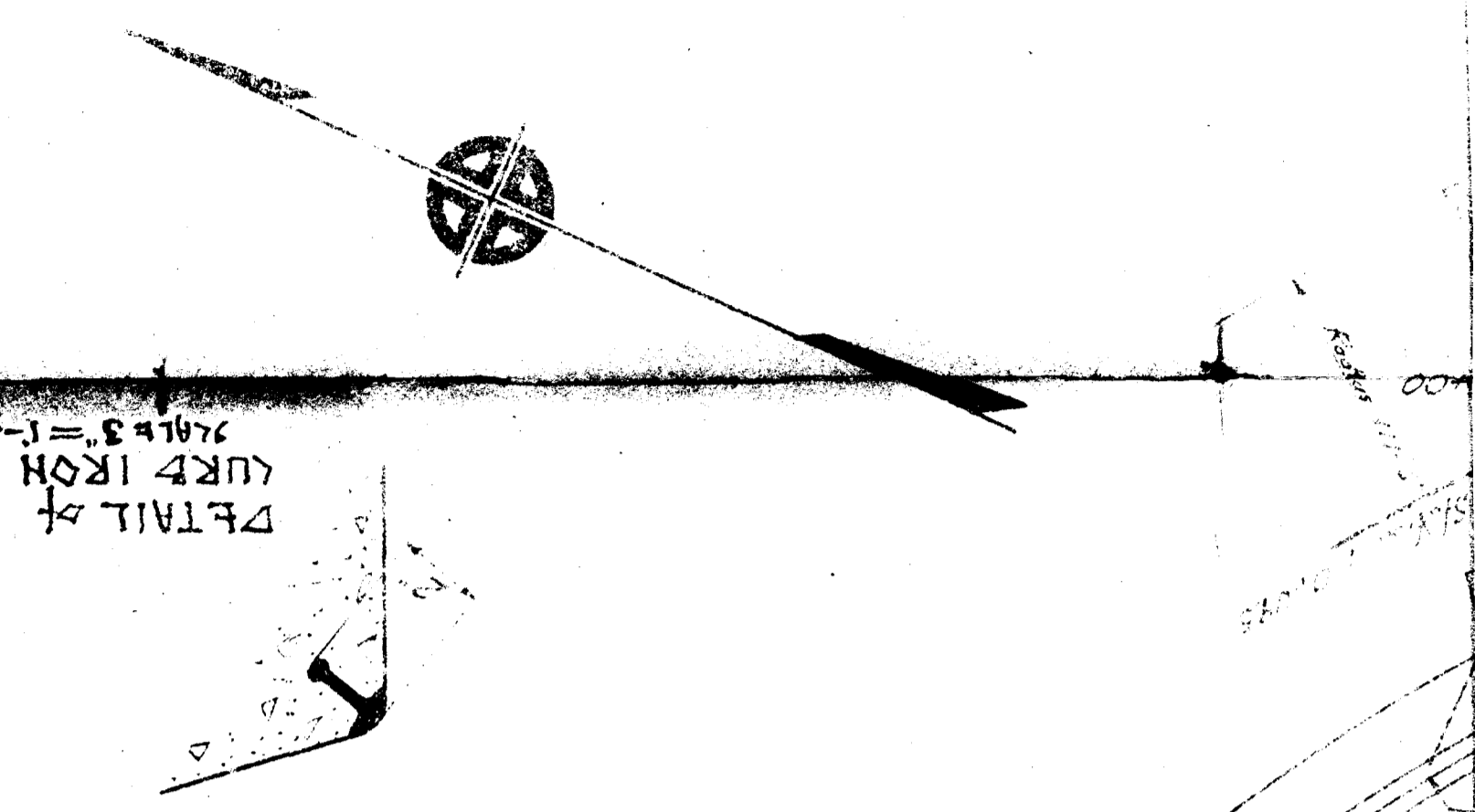
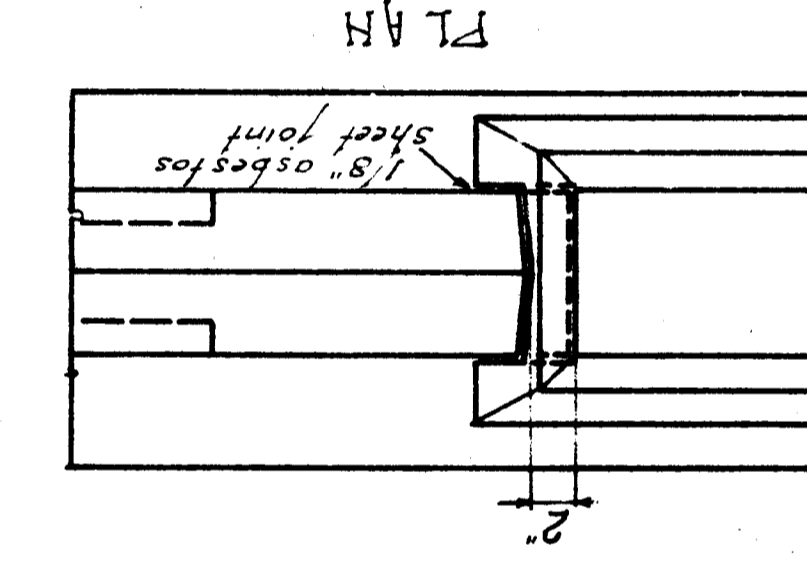
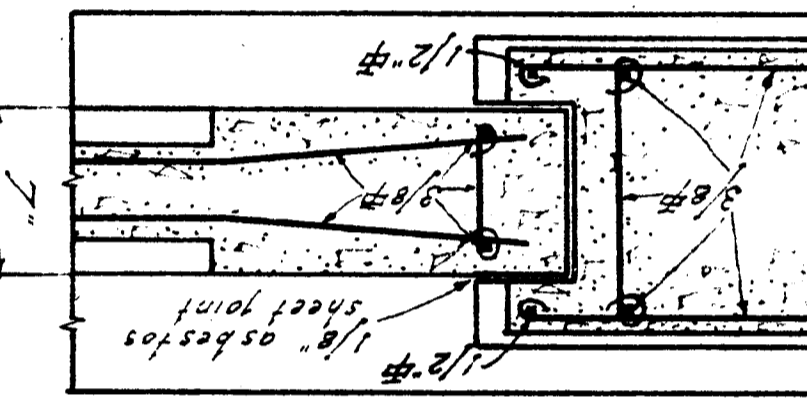

DETAIL SHOWING POSITION OF NAME PLATE

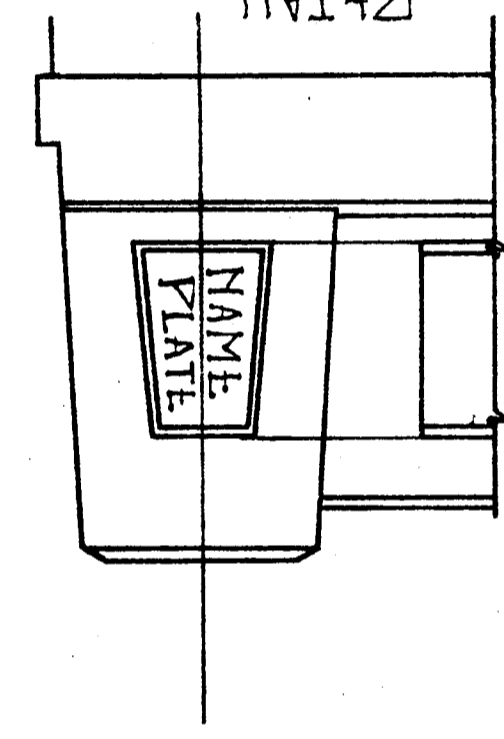

SECTION SCALE 1/2" = 1'-0"

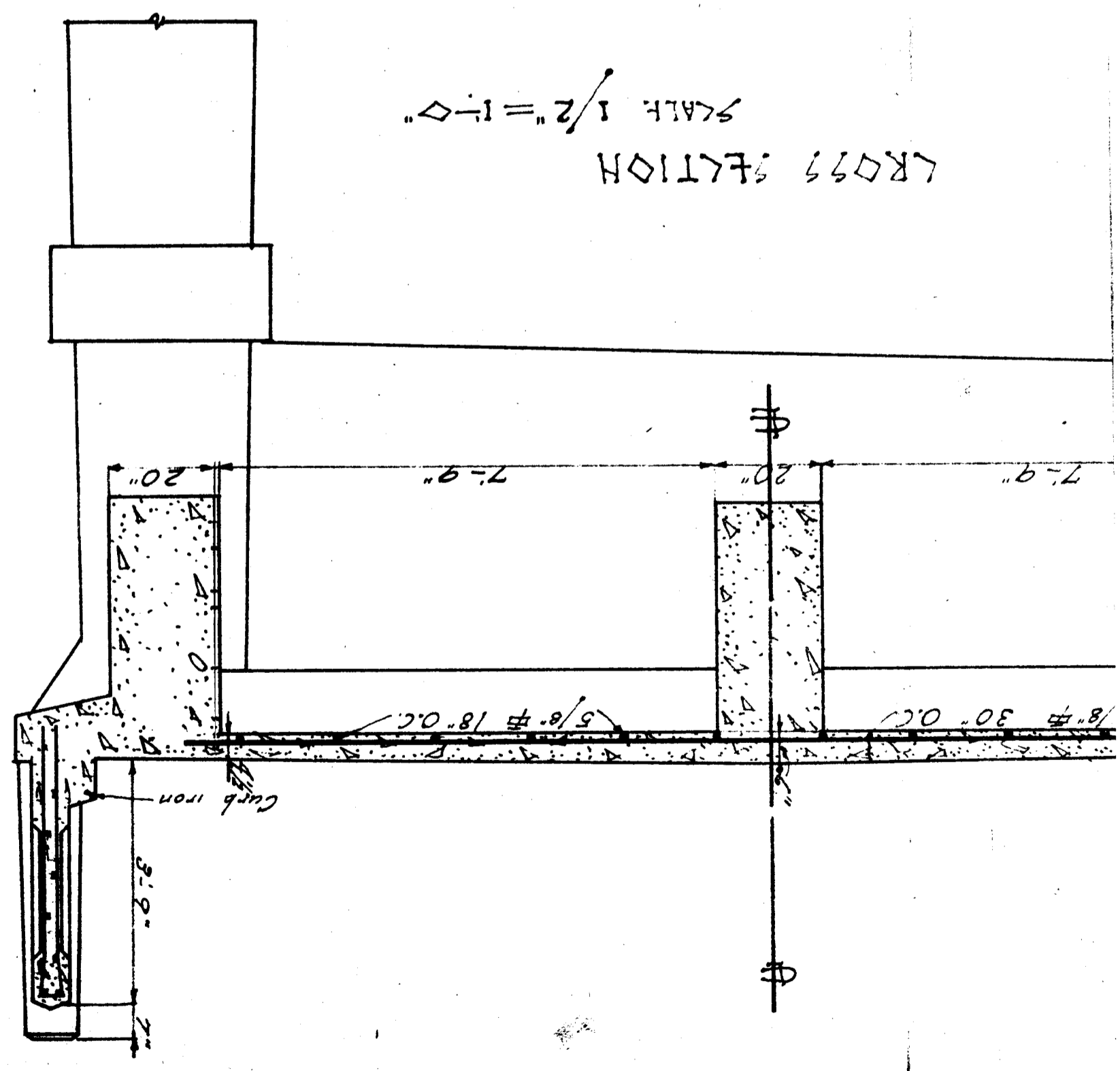

DETAIL OF PILE REINFORCEMENT
 SCALE 1/2" = 1'-0"

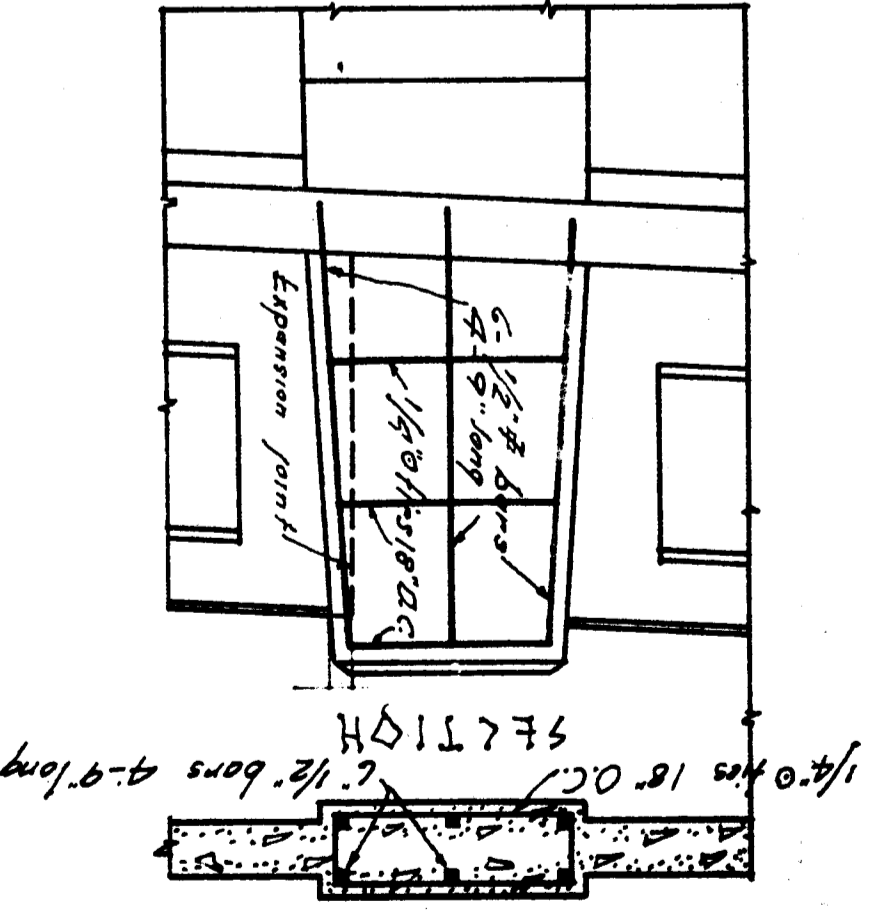

DETAILS OF COLUMNS AND FOOTINGS
 SCALE 1/2" = 1'-0"

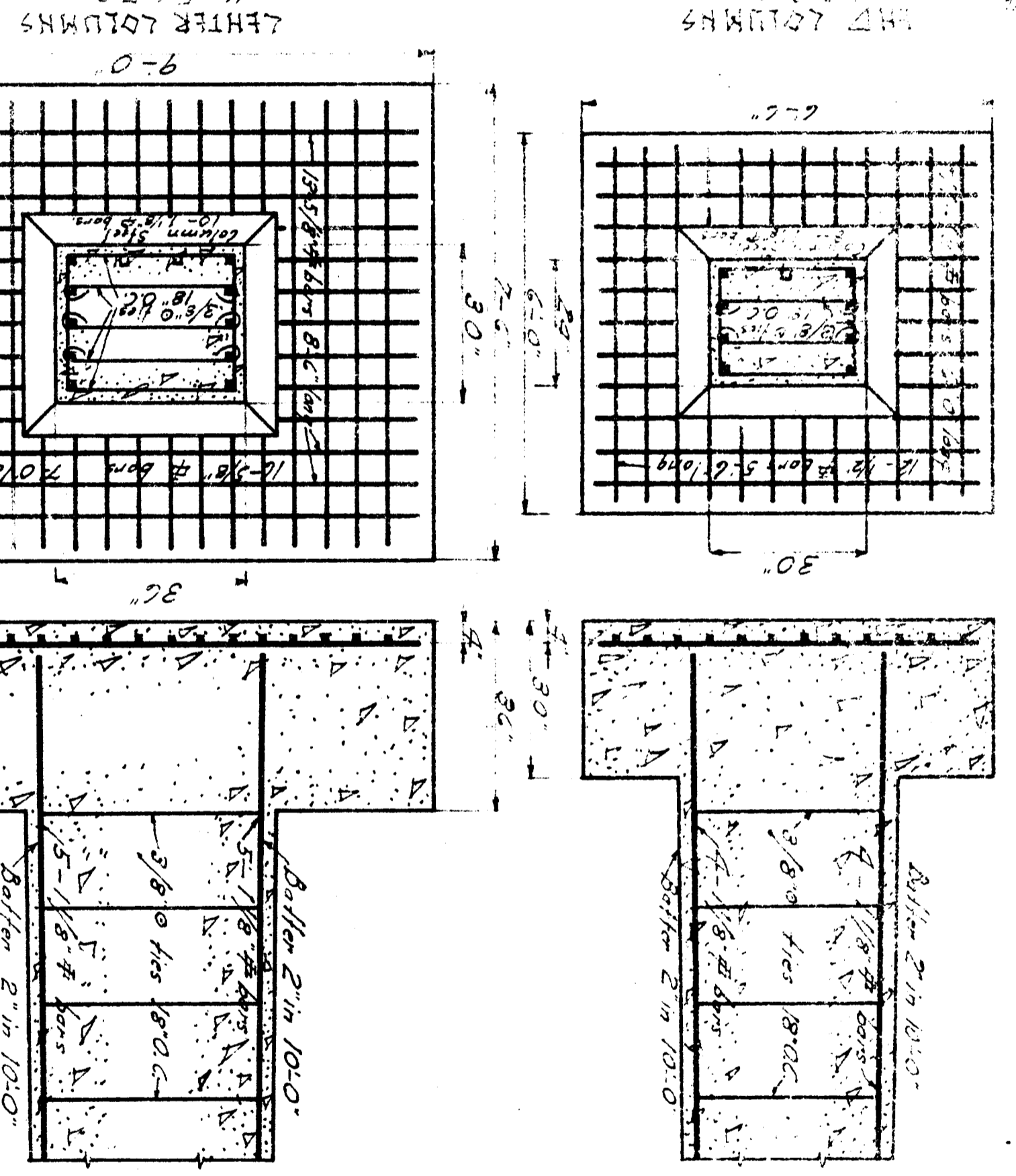

Note - Columns reinforced with 10 - 1/2" bars full length and 2 - 1/2" bars full length and 5/8" bars full length. See schedule for lengths on face of columns. Slab on face of columns. Slab on face of columns.

Note - Columns reinforced with 10 - 1/2" bars full length and 2 - 1/2" bars full length and 5/8" bars full length. See schedule for lengths on face of columns. Slab on face of columns. Slab on face of columns.

N-397

| COLUMN STEEL | |
|--------------|----|
| 10 | 10 |
| 11 | 11 |
| 12 | 12 |
| 13 | 13 |
| 14 | 14 |
| 15 | 15 |
| 16 | 16 |
| 17 | 17 |
| 18 | 18 |
| 19 | 19 |
| 20 | 20 |
| 21 | 21 |
| 22 | 22 |
| 23 | 23 |
| 24 | 24 |
| 25 | 25 |
| 26 | 26 |
| 27 | 27 |
| 28 | 28 |
| 29 | 29 |
| 30 | 30 |
| 31 | 31 |
| 32 | 32 |
| 33 | 33 |
| 34 | 34 |
| 35 | 35 |
| 36 | 36 |
| 37 | 37 |
| 38 | 38 |
| 39 | 39 |
| 40 | 40 |
| 41 | 41 |
| 42 | 42 |
| 43 | 43 |
| 44 | 44 |
| 45 | 45 |
| 46 | 46 |
| 47 | 47 |
| 48 | 48 |
| 49 | 49 |
| 50 | 50 |

